

Electronic Ballast for UVC-Lamps with adjustable Lamp Current

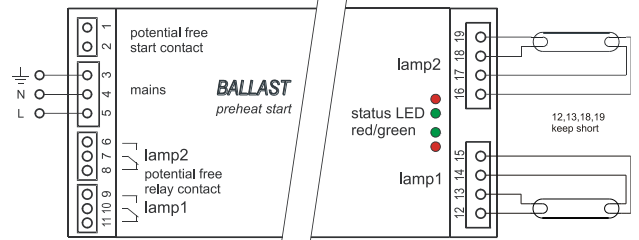

Wiring



Dimensions

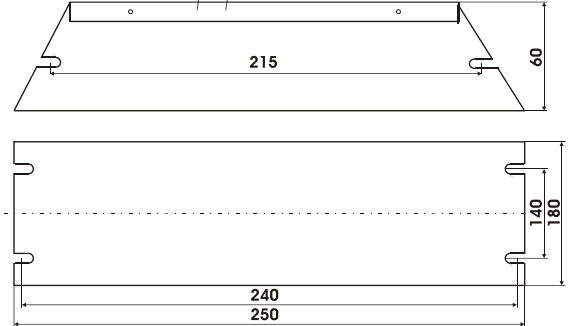

Features

- Controller based design (Cut-Off preheat start)
- Lamp current adjustable in steps
- 2 separate working lamp channels
- External/internal start alternatively
- Inrush current limiter
- 2 potential free relay contacts
- Opportunity of external potential free LED status indication

Technical Data

Type	LT-UVC 2x(320..500) W 3,2 A ..4,8 A
Supply	208/230 V AC $\pm 10\%$ 50/60 Hz
Input power min. / max.	705 W ..1100 W
Output power two lamp application	2x320 W .. 2x500 W
Adjustable range of lamp current	(3,2 A / 3,5 A / 3,8A / 4,2 A / 4,8 A) $\pm 10\%$
Powerfactor	> 0,95
Efficiency	> 0,9
Operating frequency	approx. 28..45 kHz
Inrush current	$\hat{I} < 40\text{ A to } 30\ \mu\text{s} / \hat{I} < 30\text{ A to } 300\ \mu\text{s}$
Relay Contact	1 changeover contact
Relay Contact – Maximum switching voltage	5 A 250 V AC / 5 A 24 V DC (resistive load)
Relay Contact – Recommended range	$\geq 12\text{ V} / 10\text{ mA}$
External start input	10..230 V AC / DC (potential free)
Internal / external start	Adjustable by rotating switch.
Independent	1 channel fails, other channel keeps in operation
Standby power dissipation	approx. 2 W
CE-conformity	yes

Type coding

C	Preheat start ballast (Cut-Off Technology)
M	Potential free relay contact
E	External start input
I	– selection lamp current – RS-485 interface

Adjustment of lamp current

Adjustment by rotary switch on top of the ballast		<p>Pos. 0..7: internal start (local start) – ballast starts automatically after mains turn on</p> <p>Pos. 8..15: external start (remote start) – ballast starts by external start signal at the start input</p> <p>No warranty for damages caused by incompatible lamps or wrong adjustments!</p>
Lamp typ	On request	
Adjustment of lamp current parameters	Must be carried out before voltage application, switching during operation will not be detected	

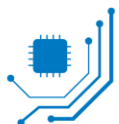

Adjustment of lamp current

Switch	Lamp current	preheat current maximal
0/8	3,2 A	3,6 A
1/9	3,2 A	4,5 A
2/10	3,5 A	4,5 A
3/11	3,8 A	4,5 A
4/12	3,5 A	5,6 A
5/13	3,8 A	5,6 A
6/14	4,2 A	5,6 A
7/15	4,8 A	5,6 A

Monitoring

Mains Control	Switch off at permanent under – or over voltage
Temperature	Switch off at permanent over temperature
Lamp presence	No start if no lamp is connected
Deactivated lamp, rectifier effect	Switch off
Shortage on the lamp line	Switch off

General indications

Operation	LED green – trouble free operation
Failure	LED red – failure, no operation
Over temperature indication (blink mode)	LED yellow – prewarning for switch off
Potential free contact PFK	Relay on – trouble free operation Relay off – failure or ballast does not start (Standby)

State indications operation/failure

Ballast status	PFK	LED green	LED red	Description	Cause
No start condition	Off	Permanent blink	Permanent blink	Ballast waits for start	- Under- or over voltage mains - Over temperature - no lamp connected - No HI level at the external start input
Ballast start/ procedure	Off	On	On	Lamp starts	
Ballast works trouble free	On	On	Off	Electronic ballast / lamp – normal mode	
Failure Temperature	Off	Off	1x blinking	Cut off at over temperature Ambient temperature too high Temperature at tc to high	- Wrong installation - No heat dissipation , surface of housing too small
Under voltage mains	Off	Off	2x blinking	Switch off at wrong mains	- Mains voltage under limit
Over voltage mains	Off	Off	3x blinking	Switch off at wrong mains	- Mains voltage over limit
Failure lamp voltage	Off	Off	4x blinking	Switch off Lamp voltage out of tolerance	- Wrong lamp type in use - End of lamp life - Deactivated lamp under operation - Rectifier effect of lamp - Start with deactivated lamp
Failure over current half bridge	Off	Off	5x blinking	Switch off by over current half bridge (abnormal operation)	- Wrong lamp wiring - Shortage on lamp lines - Start without lamps

Mounting instructions

Designed for	Installations in switch cabinet
International protection	IP20
Dimension of case	250 x 150 x 60 mm
Installation position	Vertical, mains terminal below
Ambient temperature	ta = 0..40 °C
Temperature at tc-point	tc = 50 °C max. maximum case temperature

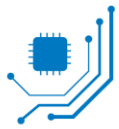

Cabling

Max. length of lamp cables	< 5 m
Max. capacitance of lamp cables	< 150 pF/m
Screened lamp cables permitted	yes

Terminal blocks

Mains Wago 231-303 3 pole Spacing 5,08 mm	Cross section: 0,75–2,5 mm ² (solid) Cross section: 0,75–1,5 mm ² (fine-stranded with ferrule)
Lamp Wago 231-304 4 pole Spacing 5,08 mm	Cross section: 0,75–2,5 mm ² (solid) Cross section: 0,75–1,5 mm ² (fine-stranded with ferrule)
potential free relay contacts Wago 734-203 3 pole Spacing 3,81 mm	Cross section: 0,2–1,5 mm ² (solid) Cross section: 0,25–1,0 mm ² (fine-stranded with ferrule)
external start input Wago 734-202 2 pole Spacing 3,81 mm	Cross section: 0,2–1,5 mm ² (solid) Cross section: 0,25–1,0 mm ² (fine-stranded with ferrule)

Communication parameters

Baud rate	9600
Date bit	8
Stop bit	1
Parity	none

Wiring RS-485 interface

Maximum number of slaves	32
Bus termination	120 Ohm resistor at both ends of the network

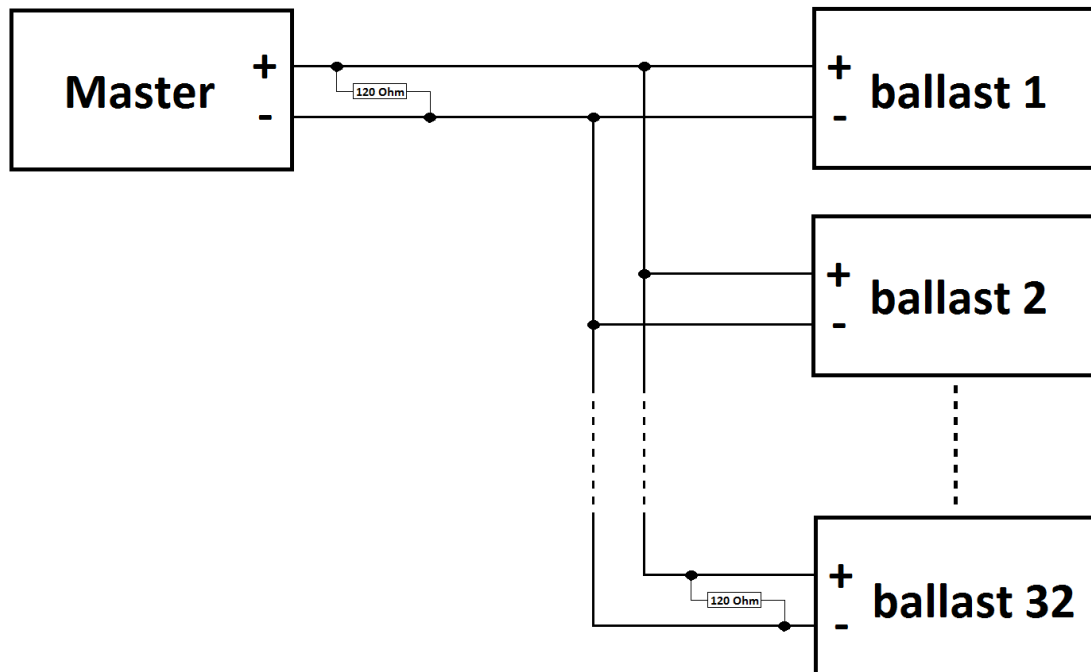

Addressing

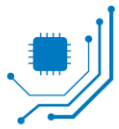

Ballast-address	DIP-switch				
	1	2	3	4	5
1	0	0	0	0	0
2	1	0	0	0	0
3	0	1	0	0	0
4	1	1	0	0	0
5	0	0	1	0	0
6	1	0	1	0	0
7	0	1	1	0	0
8	1	1	1	0	0
9	0	0	0	1	0
10	1	0	0	1	0
11	0	1	0	1	0
12	1	1	0	1	0
13	0	0	1	1	0
14	1	0	1	1	0
15	0	1	1	1	0
16	1	1	1	1	0
17	0	0	0	0	1
18	1	0	0	0	1
19	0	1	0	0	1
20	1	1	0	0	1
21	0	0	1	0	1
22	1	0	1	0	1
23	0	1	1	0	1
24	1	1	1	0	1
25	0	0	0	1	1
26	1	0	0	1	1
27	0	1	0	1	1
28	1	1	0	1	1
29	0	0	1	1	1
30	1	0	1	1	1
31	0	1	1	1	1
32	1	1	1	1	1

Function code

Function code	MODBUS function	Register
01	Read Boolean variables	1 - 3
03	Read Numeric variables	4001 - 4017
05	Set Single Boolean variables	1 - 3

Data

Register	Address	Name	Description	Data type
1	0x00	Power	0 = ON (ballast works) 1 = OFF (ballast in standby)	Boolean
2	0x01	RESET lamp 1 Operating time counter/Start counter	0 = Operating 1 = Set counter to 0	Boolean
3	0x02	RESET lamp 2 Operating time counter/Start counter	0 = Operating 1 = Set counter to 0	Boolean
4001	0x00	Ballast address	Displays the set ballast address (1 - 32)	Word
4002	0x01	Ballast type	1 = LT-UVC2x(30..80)W-R/M/E/I 0,35..0,8 A 2 = LT-UVC2x(30..80)W-R/M/E/I 0,8..1,5 A 3 = LT-UVC2x(60..100)W-R/M/E/I 0,35..0,65 A 4 = LT-UVC2x(80..125)W-R/M/E/I 0,8..1,5 A 5 = LT-UVC2x(100..200)W-C/M/E/I 1,2..2,1 A	Word
4003	0x02	Switch position	Displays the adjustment of lamp current (0 - 9)	Word

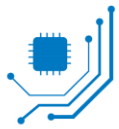

4004	0x03	State lamp 1	1 = Ballast start 2 = Lamp preheating 3 = Ballast works 4 = Ballast waits for start 5 = Reserved 6 = Failure – Temperature 7 = Failure – Under voltage mains 8 = Failure – Over voltage mains 9 = Failure – Lamp voltage 10 = Failure – Over current 11 = Failure – Over current Preheating	Word
4005	0x04	State lamp 2	1 = Ballast start 2 = Lamp preheating 3 = Ballast works 4 = Ballast waits for start 5 = Reserved 6 = Failure – Temperature 7 = Failure – Under voltage mains 8 = Failure – Over voltage mains 9 = Failure – Lamp voltage 10 = Failure – Over current 11 = Failure – Over current Preheating	Word
4006	0x05	Operating time counter lamp 1 - Minute	Displays the operating time in minutes (0 - 60 min.) - counter only works in state 3 -	Word
4007	0x06	Operating time counter lamp 1 - Hour	Displays the operating time in hours (0 - 65535 h) - counter only works in state 3 -	Word
4008	0x07	Operating time counter lamp 2 - Minute	Displays the operating time in minutes (0 - 60 min.) - counter only works in state 3 -	Word
4009	0x08	Operating time counter lamp 2 - Hour	Displays the operating time in hours (0 - 65535 h) - counter only works in state 3 -	Word
4010	0x09	Start counter lamp1	Displays the number of lamp starts (0 - 65535)	Word
4011	0x0A	Start counter lamp2	Displays the number of lamp starts (0 - 65535)	Word
4012	0x0B	Ballast temperature	Displays the temperature of the ballast in °C (ballast switch off at approx. 80 °C) - does not reflect the temperature at the case(tc-point) -	Word
4013	0x0C	Main voltage	1 = Mains voltage under limit ($U_{\text{Netz}} < 187 \text{ V}$) 2 = Typical tolerance ($187 \text{ V} < U_{\text{Netz}} < 253 \text{ V}$) 3 = Mains voltage over limit ($U_{\text{Netz}} > 253 \text{ V}$)	Word
4014	0x0D	Lamp voltage lamp 1	Displays the lamp voltage in V ($\pm 10\%$)	Word
4014	0x0D	Lamp voltage lamp 2	Displays the lamp voltage in V ($\pm 10\%$)	Word
4014	0x0D	Lamp current lamp 1	Displays the lamp current in mA ($\pm 10\%$)	Word
4014	0x0D	Lamp current lamp 2	Displays the lamp current in mA ($\pm 10\%$)	Word

Checksum

Calculation algorithm	CRC 16
Generator polynomial	0x8005
CRC-start value	0xFFFF

Error control

Error code	Description
0x01	Using an unsupported function code
0x02	Using an invalid memory address